

TECHNICAL INFORMATIONS

SCHOOL WALL WASH CCT

30W BRANCA

A School Wall Wash é uma Luminária com feixe de luz assimétrico e contínuo com controle óptico excepcional para iluminação uniforme e sem sombras.

School Wall Wash is a Luminaire with assymetric and seamless beam of light with exceptional optical control for uniform, shadow-free illumination.

A School Wall Wash es una luminaria con feixe de luz asimétrica y contínuo con control óptico excepcional para iluminación uniforme y sem sombras.



ILAR-01594

REFERENCE		DIMENSION & WEIGHT		PHOTOMETRICAL DATA	
Reference	ILAR-01594	Lenght	615x62x29mm	Total Luminous Flux	1250-1450lm
LED Brand	-	Width	-	Luminous Efficacy	110-120lm/w
Mounting Type	Recessed	Height	-	Beam Angle	60°/36°x20°
Body Material	Aluminium	Weight	-	Colour Temperature	3000K-4000K-5000K
Housing Colour	White RAL9016	Cutout	607x54mm	Colour Rendering Index	>90
Body Shape	Rectangular	Packaging Unit	1pc/carton	Colour Consistency	-
Nominal Lifetime (EOL end of life)	50.000H	Gross Weight	-	UGR	-
Dimming Options	1-10V / DALI				

ELECTRICAL AND OPERATING DATA		ENERGY LABEL & STANDARS		CERTIFICATIONS	
Nominal Wattage	30W	Energy Label	-	2014/30/EU (EMC Directive)	YES
Nominal Voltage	200-240V	Energy Consumption KWH/1000H	-	2014/35/EU (LVD Directive)	YES
Operating Frequency	50Hz	Type of Protection	IP40	ROHS	YES
Power Factor	≥0.5	Protection Class	Class II	Warranty	3 YEARS
Operating Temperature	-20°C to +45°C	Protection Class IK (shock resistance)	IK07		
Starting Time 100% ON	0.5s				
ON/OFF Cycles	100000				

SIZE

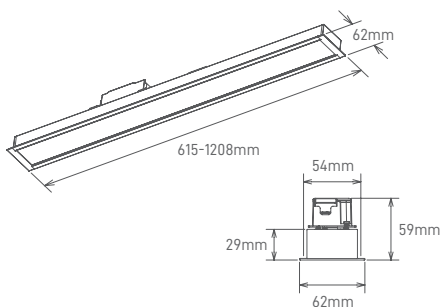

BEAM ANGLE

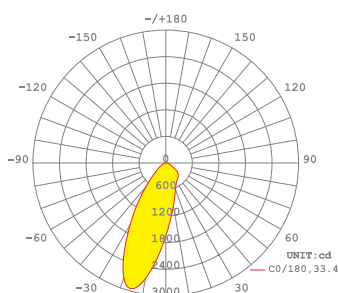

Designed by Aronlight in Portugal. Made in PRC

