

TECHNICAL INFORMATIONS

PROJETOR LED IP65

20W 4500K WHITE

Série profissional de projetores IP65 com 94% de eficiência luminosa, corpo em alumínio fundido de alta intensidade, vidro temperado de alta qualidade que resiste ao impacto e ao atrito.

Professional floodlight series with 94% luminous efficiency, body of high intensity die-cast aluminum, high quality tempered glass that resist the impact and friction.

Serie profesional de proyectores IP65 con un 94% de eficiencia luminosa, cuerpo de aluminio fundido de alta intensidad, vidrio templado de alta calidad que resiste el impacto y la fricción.



ILAR-00532

REFERENCE		DIMENSION & WEIGHT		PHOTOMETRICAL DATA	
Reference	ILAR-00532	Size Piece	150x145x27mm	Total Luminous Flux	1700lm
Led Type	Epistar LED	Weight Piece	-	Luminous Efficacy	90Lm/W
Body Material	Die Cast Aluminium	Item Volume	-	Beam Angle	120°
Body Colour	White	Itens per Pack	1	Colour Temperature	4500K
Nominal Lifetime	30000h	Itens per Box	20 pcs / carton	Colour Rendering Index	>80
Dimmable	No			Colour Stability	<6
Cable Size	50cm				

ELECTRICAL AND OPERATING DATA		ENERGY LABEL & STANDARS		CERTIFICATIONS	
Nominal Wattage	20W	Energy Label	A+	CE Directive	YES
Nominal Voltage	AC220-240V	Energy Consumption KWH/1000H	6KWH	ROHS	YES
ON/OFF Cycles	>15000	Type of Protection	IP65	Warranty	2 YEARS
Operating Frequency	50/60Hz	Protection Class	Class I		
Power Factor	>0.9	Protecion Class IK (shock resistance)	IK06		
Operating Temperature	- 30° C to + 40° C				
Power Supply	DOB				

SIZE

BEAM ANGLE

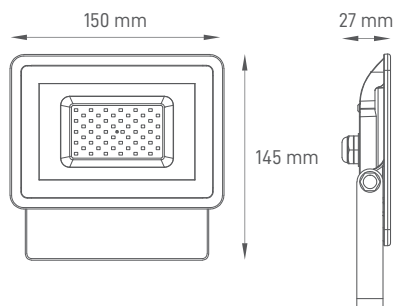

Designed by Aron Light in Portugal Made in PRC

